

CITY MULTI ^{<ORIGINAL>}

Air-Conditioners

INDOOR UNIT

PEFY-P-VMR-E-L/R

PEFY-P-VMHS-E-F

PLFY-P-VLMD-E

PFFY-P-VLRM(M)-E

PFFY-P-VLEM-E

PEFY-P-VMH-E

PEFY-P-VMA(L)-E

PEFY-P-VMH-E-F

PEFY-P-VMHS-E



OPERATION MANUAL

For safe and correct use, please read this operation manual thoroughly before operating the air-conditioner unit.

GB

[Fig.A]

<PLFY-P20~100VLMD-E>

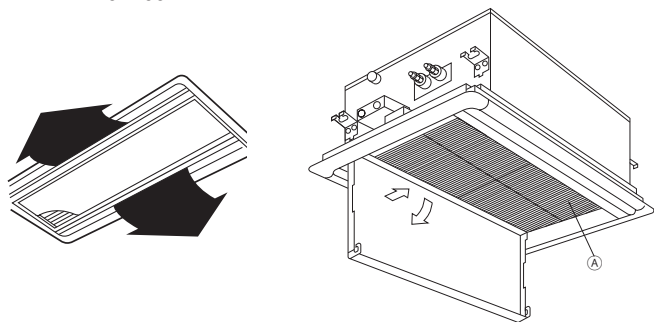

<PLFY-P125VLMD-E>

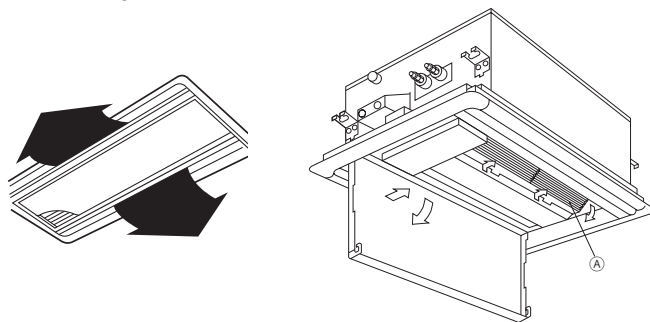

<PEFY-P-VMH-E, VMH-E-F, VMHS-E, VMHS-E-F>

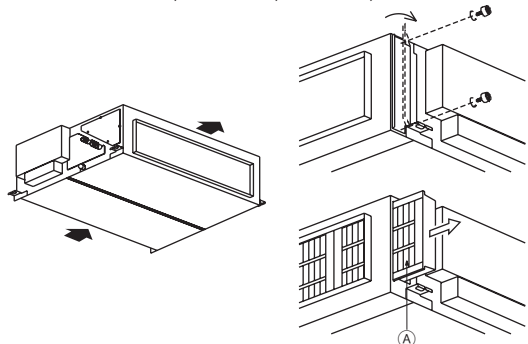

<PFFY-P-VLEM-E, VLRM(M)-E>

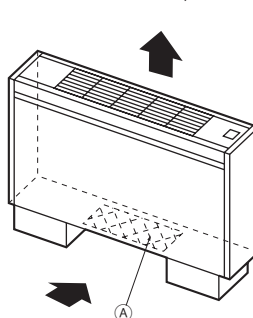

<PEFY-P-VMA(L)-E>

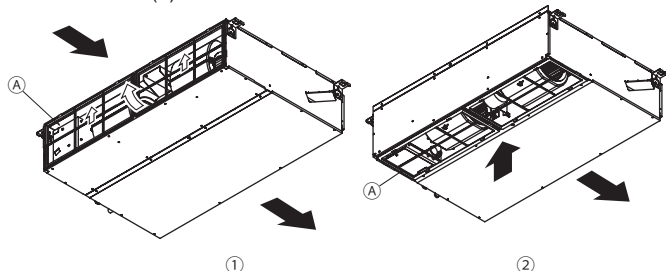

<PEFY-P-VMR-E-L/R>

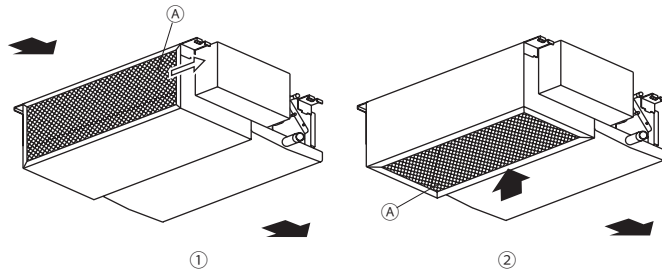

① Air inlet on the rear
 Luftenlass auf der Rückseite
 Admission d'air par l'arrière
 Entrada de aire en la parte posterior
 Ingresso aria sul retro
 Luchtinlaat aan de achterkant
 Entrada de ar na parte posterior
 Είσοδος αέρα από πίσω
 Воздухозаборник сзади
 Arkadaki hava girişi
 后部进气口
 後側進氣口
 Přívod vzduchu v zadní části
 Prívod vzduchu na zadnej strane
 Légbeömlő nyílás a hátoldalon
 Wlot powietrza z tyłu
 Vstop zraka na zadnji strani
 Luftintag på baksidan
 Ulaz za zrak straga
 Вход за въздух от задната страна
 Admisia aerului prin partea din spate
 Luftinntak på baksiden

② Air inlet at the bottom
 Luftenlass auf der Unterseite
 Admission d'air par le bas
 Entrada de aire en la parte inferior
 Ingresso aria nella parte inferiore
 Luchtinlaat aan de onderkant
 Entrada de ar na parte inferior
 Είσοδος αέρα από κάτω
 Воздухозаборник внизу
 Alttaki hava girişi
 底部进气口
 底部進氣口
 Přívod vzduchu ve spodní části
 Prívod vzduchu na spodnej strane
 Légbeömlő nyílás az alsó oldalon
 Wlot powietrza z dołu
 Vstop zraka na spodnji strani
 Luftintag på undersidan
 Ulaz za zrak na dnu
 Вход за въздух от долната страна
 Admisia aerului prin partea inferioară
 Luftinntak i bunnen

Ⓐ Filter
 Filter
 Filtre
 Filtre
 Filtro
 Filtro
 Filtro
 Filtro
 Фільтро
 Фильтр
 Filtre
 滤网
 濾網
 Filtr
 Filter
 Szűrő
 Filtr
 Filter
 Filtre
 Filtre
 Filtre
 Филтър
 Filtru
 Filter

➔ Air flow
 Luftfluss
 Flux d'air
 Fluxo de aire
 Flusso d'aria
 Richting van de luchtstroom
 Fluxo de ar
 Річчя аєра
 Воздушный поток
 Hava akışı
 气流
 氣流
 Prútok vzduchu
 Prúdenie vzduchu
 Légáramlás
 Przepływ powietrza
 Pretok zraka
 Luftflöde
 Protok zraka
 Въздушен поток
 Fluxul de aer
 Luftstrømning

Operation Section

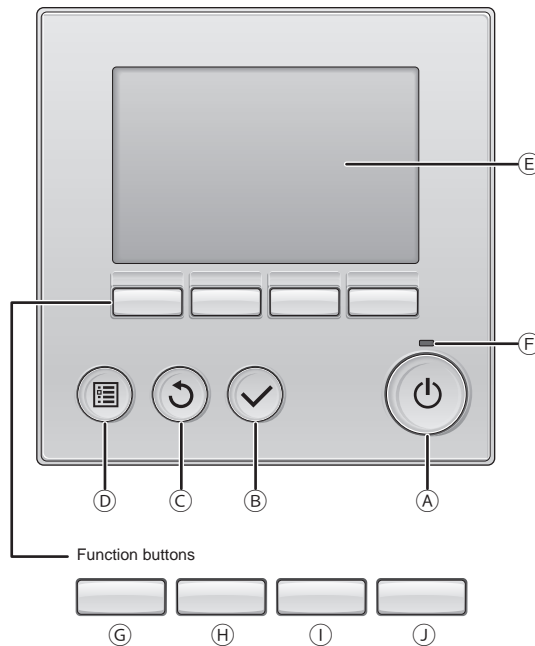

A [ON/OFF] button

Press to turn ON/OFF the indoor unit.

B [SELECT] button

Press to save the setting.

C [RETURN] button

Press to return to the previous screen.

D [MENU] button

Press to bring up the Main menu.

E Backlit LCD

Operation settings will appear.
When the backlight is off, pressing any button turns the backlight on and it will stay lit for a certain period of time depending on the screen.

When the backlight is off, pressing any button turns the backlight on and does not perform its function. (except for the [ON/OFF] button)

F ON/OFF lamp

This lamp lights up in green while the unit is in operation. It blinks while the remote controller is starting up or when there is an error.

The functions of the function buttons change depending on the screen. Refer to the button function guide that appears at the bottom of the LCD for the functions they serve on a given screen.

When the system is centrally controlled, the button function guide that corresponds to the locked button will not appear.

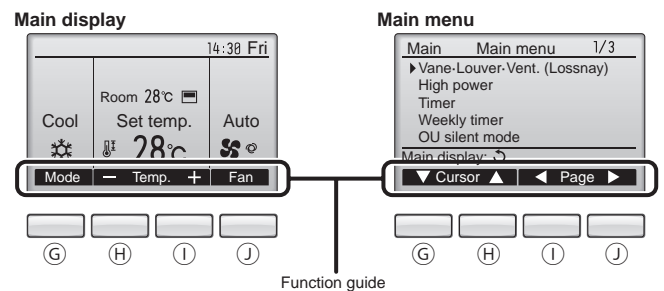

G Function button [F1]

Main display: Press to change the operation mode.
Main menu: Press to move the cursor down.

H Function button [F2]

Main display: Press to decrease temperature.
Main menu: Press to move the cursor up.

I Function button [F3]

Main display: Press to increase temperature.
Main menu: Press to go to the previous page.

J Function button [F4]

Main display: Press to change the fan speed.
Main menu: Press to go to the next page.

Display Section

The main display can be displayed in two different modes: "Full" and "Basic."
The factory setting is "Full." To switch to the "Basic" mode, change the setting on the "Main display" setting screen (Main menu > Initial setting > Main display).

Full mode

* All icons are displayed for explanation.

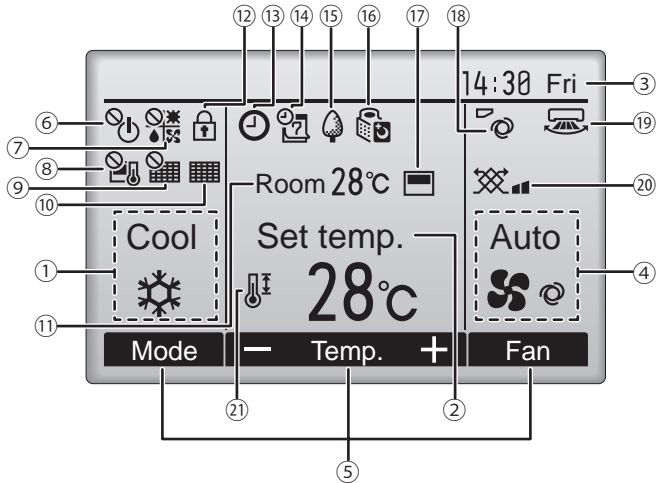

Basic mode

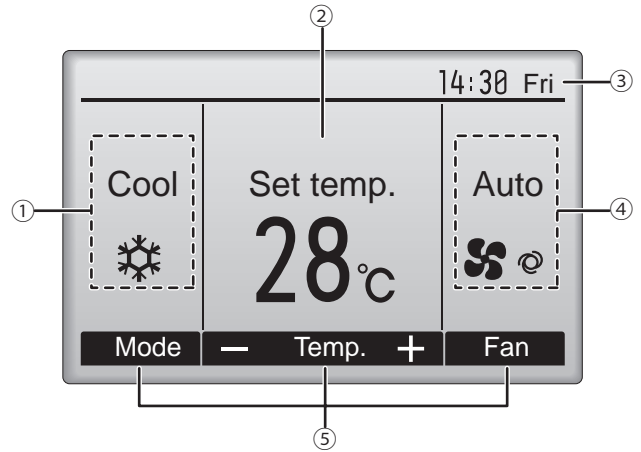

① Operation mode

Indoor unit operation mode appears here.

② Set temperature

Set temperature appears here.

③ Clock

Current time appears here.

④ Fan speed

Fan speed setting appears here.

⑤ Button function guide

Functions of the corresponding buttons appear here.



Appears when the ON/OFF operation is centrally controlled.



Appears when the operation mode is centrally controlled.



Appears when the set temperature is centrally controlled.



Appears when the filter reset function is centrally controlled.



Indicates when filter needs maintenance.

⑪ Room temperature

Current room temperature appears here.



Appears when the buttons are locked.



Appears when the On/Off timer, Night setback, or Auto-off timer function is enabled.

appears when the timer is disabled by the centralized control system.



Appears when the Weekly timer is enabled.



Appears while the units are operated in the energy-save mode. (Will not appear on some models of indoor units)



Appears while the outdoor units are operated in the silent mode.



Appears when the built-in thermistor on the remote controller is activated to monitor the room temperature (⑪).

appears when the thermistor on the indoor unit is activated to monitor the room temperature.



Indicates the vane setting.



Indicates the louver setting.



Indicates the ventilation setting.



Appears when the set temperature range is restricted.

Most settings (except ON/OFF, mode, fan speed, temperature) can be made from the Main menu.

Contents

1. Safety precautions.....	5	3.4. Fan speed.....	8
1.1. Installation.....	5	3.5. Vane/Ventilation (Lossnay).....	9
1.2. During operation.....	5	4. The smart way to use.....	9
1.3. Disposing of the unit.....	6	5. Caring for the machine.....	9
2. Names and functions of various parts.....	6	6. Troubleshooting.....	10
3. How to operate.....	7	7. Installation, transferring works, and checking.....	11
3.1. Turning ON/OFF.....	7	8. Specifications.....	12
3.2. Operation mode.....	7		
3.3. Set temperature.....	8		

1. Safety precautions

- ▶ Before operating the unit, make sure you read all the “Safety precautions”.
- ▶ “Safety precautions” lists important points about safety. Please be sure to follow them.

Symbols used in the text

⚠ Warning:
Describes precautions that should be observed to avoid the risk of injury or death to the user.

⚠ Caution:
Describes precautions that should be observed to prevent damage to the unit.

Symbols used in the illustrations

- ⊘ : Indicates an action that must be avoided.
- ❗ : Indicates that important instructions must be followed.
- ⚡ : Indicates a part which must be grounded.
- ⚠ : Indicates that caution should be taken with rotating parts. (This symbol is displayed on the main unit label.) <Color: yellow>
- ⚠ : Beware of electric shock. (This symbol is displayed on the main unit label.) <Color: yellow>

- ⚠ Warning:**
Carefully read the labels affixed to the main unit.

1.1. Installation

- ▶ After you have read this manual, keep it and the Installation Manual in a safe place for easy reference whenever a question arises. If the unit is going to be operated by another person, make sure that this manual is given to him or her.

⚠ Warning:

- The unit should not be installed by the user. Ask the dealer or an authorized company to install the unit. If the unit is installed improperly, water leakage, electric shock or fire may result.
- Use only accessories authorized by Mitsubishi Electric and ask your dealer or an authorized company to install them. If accessories are installed improperly, water leakage, electric shock or fire may result.
- The Installation Manual details the suggested installation method. Any structural alteration necessary for installation must comply with local building code requirements.
- Never repair the unit or transfer it to another site by yourself. If repair is performed improperly, water leakage, electric shock or fire may result. If you need to have the unit repaired or moved, consult your dealer.
- Keep the electric parts away from water (washing water) etc.
- It might result in electric shock, catching fire or smoke.

Note 1: When washing the Heat Exchanger and Drain Pan, ensure the Control Box, Motor and LEV remain dry, using a water proof covering.

Note 2: Never drain the washing water for the Drain Pan and the Heat Exchanger using the Drain Pump. Drain separately.

- This appliance is not intended for use by persons (including children) with reduced physical, sensory or mental capabilities, or lack of experience and knowledge, unless they have been given supervision or instruction concerning use of the appliance by a person responsible for their safety.
- This appliance is intended to be used by expert or trained users in shops, in light industry and on farms, or for commercial use by lay persons.
- Do not use a leak detection additive.
- Do not use refrigerant other than the type indicated in the manuals provided with the unit and on the nameplate.
 - Doing so may cause the unit or pipes to burst, or result in explosion or fire during use, during repair, or at the time of disposal of the unit.
 - It may also be in violation of applicable laws.
 - MITSUBISHI ELECTRIC CORPORATION cannot be held responsible for malfunctions or accidents resulting from the use of the wrong type of refrigerant.

1)Outdoor unit

⚠ Warning:

- The outdoor unit must be installed on a stable, level surface, in a place where there is no accumulation of snow, leaves or rubbish.
- Do not stand on, or place any items on the unit. You may fall down or the item may fall, causing injury.

⚠ Caution:

- The outdoor unit should be installed in a location where air and noise emitted by the unit will not disturb the neighbours.

2)Indoor unit

⚠ Warning:

- The indoor unit should be securely installed. If the unit is loosely mounted, it may fall, causing injury.

3)Remote controller

⚠ Warning:

- The remote controller should be installed in such a way that children cannot play with it.

4)Drain hose

⚠ Caution:

- Make sure that the drain hose is installed so that drainage can go ahead smoothly. Incorrect installation may result in water leakage, causing damage to furniture.

5)Power line, fuse or circuit breaker

⚠ Warning:

- Make sure that the unit is powered by a dedicated supply. Other appliances connected to the same supply could cause an overload.
- Make sure that there is a main power switch.
- Be sure to adhere to the unit's voltage and fuse or circuit breaker ratings. Never use a piece of wire or a fuse with a higher rating than the one specified.

6)Grounding

⚠ Caution:

- The unit must be properly grounded. Never connect the grounding wire to a gas pipe, water pipe, lightning conductor or telephone grounding wire. If the unit is not grounded properly, electric shock may result.
- Check frequently that the ground wire from the outdoor unit is properly connected to both the unit's ground terminal and the grounding electrode.

1.2. During operation

⚠ Warning:

- Do not splash water over the unit and do not touch the unit with wet hands. An electric shock may result.
- Do not spray combustible gas close to the unit. Fire may result.
- Do not place a gas heater or any other open-flame appliance where it will be exposed to the air discharged from the unit. Incomplete combustion may result.
- Do not remove the front panel or the fan guard from the outdoor unit when it is running. You could be injured if you touch rotating, hot or high-voltage parts.
- Never insert fingers, sticks etc. into the intakes or outlets, otherwise injury may result, since the fan inside the unit rotates at high speed. Exercise particular care when children are present.
- If you detect odd smells, stop using the unit, turn off the power switch and consult your dealer. Otherwise, a breakdown, electric shock or fire may result.
- When you notice exceptionally abnormal noise or vibration, stop operation, turn off the power switch, and contact your dealer.
- Do not over-cool. The most suitable inside temperature is one that is within 5 °C of the outside temperature.
- Do not leave handicapped people or infants sitting or standing in the path of the airflow from the air-conditioner. This could cause health problems.

⚠ Caution:

- Do not use any sharp object to push the buttons, as this may damage the remote controller.
- Do not twist or tug on the remote controller cord as this may damage the remote controller and cause malfunction.
- Never remove the upper case of the remote controller. It is dangerous to remove the upper case of the remote controller and touch the printed circuit boards inside. Doing so can result in fire and failure.
- Never wipe the remote controller with benzene, thinner, chemical rags, etc. Doing so can result in discoloration and failure. To remove heavy stains, soak a cloth in neutral detergent mixed with water, wring it out thoroughly, wipe the stains off, and wipe again with a dry cloth.
- Never block or cover the indoor or outdoor unit's intakes or outlets. Tall items of furniture underneath the indoor unit, or bulky items such as large boxes placed close to the outdoor unit will reduce the unit's efficiency.
- Do not direct the airflow at plants or caged pets.
- Ventilate the room frequently. If the unit is operated continuously in a closed room for a long period of time, the air will become stale.

In case of failure

⚠ Warning:

- Never remodel the air conditioner. Consult your dealer for any repair or service. Improper repair work can result in water leakage, electric shock, fire, etc.
- If the remote controller displays an error indication, the air conditioner does not run, or there is any abnormality, stop operation and contact your dealer. Leaving the unit as it is under such conditions can result in fire or failure.
- If the power breaker is frequently activated, get in touch with your dealer. Leaving it as it is can result in fire or failure.
- If the refrigeration gas blows out or leaks, stop the operation of the air conditioner, thoroughly ventilate the room, and contact your dealer. Leaving the unit as it is can result in accidents due to oxygen deficiency.

When the air conditioner is not to be used for a long time

- If the air conditioner is not to be used for a long time due to a seasonal change, etc., run it for 4 - 5 hours with the air blowing until the inside is completely dry. Failing to do so can result in the growth of unhygienic, unhealthy mold in scattered areas throughout the room.
- When it is not to be used for an extended time, keep the power supply turned OFF. If the power supply is kept on, several watts or several tens of watts will be wasted. Also, the accumulation of dust, etc., can result in fire.
- Keep the power switched ON for more than 12 hours before starting operation. Do not turn the power supply OFF during seasons of heavy use. Doing so can result in failure.

1.3. Disposing of the unit

⚠ Warning:

- When you need to dispose of the unit, consult your dealer. If pipes are removed incorrectly, refrigerant (fluorocarbon gas) may blow out and come into contact with your skin, causing injury. Releasing refrigerant into the atmosphere also damages the environment.

2. Names and functions of various parts

Attachment and detachment of filter

[Fig. A] (P.2)

⚠ Caution:

- In removing the filter, precautions must be taken to protect your eyes from dust. Also, if you have to climb up on a stool to do the job, be careful not to fall.
- Turn off the power supply when the filter is changed.

3. How to operate

3.1. Turning ON/OFF

ON

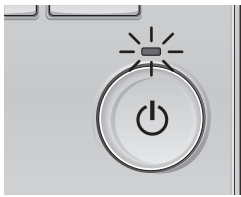

Press the [ON/OFF] button.
The ON/OFF lamp will light up in green, and the operation will start.

* The unit will operate with the previously-set operation mode, set temperature, and fan speed.

OFF

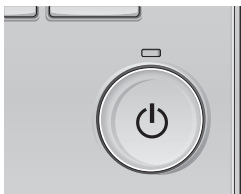

Press the [ON/OFF] button again.
The ON/OFF lamp will come off, and the operation will stop.

3.2. Operation mode

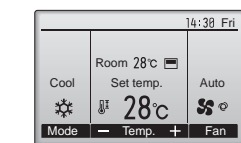

Press the [F1] button to go through the operation modes in the order of "Cool, Dry, Fan, Auto, and Heat."
Select the desired operation mode.

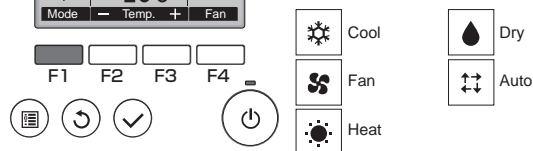

* Operation modes that are not available for the connected indoor unit will not appear on the display.

* Depending on the indoor unit model, either one or two set temperatures (single or dual set point(s)) can be set for Auto mode.

What the blinking mode icon means

The mode icon will blink when other indoor units in the same refrigerant system (connected to the same outdoor unit) are already operated in a different mode. In this case, the rest of the units in the same group can only be operated in the same mode.

Dry mode (Excluding PEFY-P-VMHS-E-F series)

- The indoor fan turns to the low-speed operation, disabling the change of fan speed.
- Dry operation cannot be carried out at room temperature of less than 18°C.
- The dry is a microcomputer-controlled dehumidifying operation which controls excessive air-cooling according to the room temperature of your choice. (Not usable for heating.)

- Until reaching room temperature of your choice
The compressor and indoor fan function is linked motion according to the change of the room temperature and automatically repeat ON/OFF.
- When reaching room temperature of your choice
Both the compressor and indoor fan stop.
When stop continues for 10 minutes, the compressor and indoor fan are operated for 3 minutes to keep the humidity low.

Heat mode

"DEFROST" display

Displayed only during the defrosting operation.

"STAND BY" display

Displayed from the start of heating operation until the moment warm air blows out.

⚠ Caution:

- Never expose your body directly to cool air for a long time. Excessive exposure to cool air is bad for your health, and should therefore be avoided.
- When the air-conditioner is used together with burners, thoroughly ventilate the area. Insufficient ventilation can result in accidents due to oxygen deficiency.
- Never place a burner at a place where it is exposed to the airflow from the air-conditioner. Doing so can result in imperfect combustion of the burner.
- The microcomputer functions in the following cases:
 - Air does not blow out when heating starts.
 - To prevent any cool air from escaping, the indoor fan is gradually switched in sequence from faint airflow/weak airflow/set airflow according to the temperature rise of the blown out air. Wait a moment until the airflow comes out naturally.
 - The fan is not moving at the set speed.
 - In some models, the system switches over to faint airflow when the temperature of the room reaches the set temperature. In other cases, it stops to prevent any cool air from escaping during the defrosting operation.
- Air flows out even if operation is stopped.
 - Approximately 1 minute after the stop of operation, the indoor fan sometimes rotates to eliminate extra heat generated by the electric heater, etc. The fan speed comes to low or high.

Auto (dual set point) mode (Excluding PEFY-P-VMHS-E-F series)

When the operation mode is set to the Auto (dual set point) mode, two set temperatures (one each for cooling and heating) can be set. Depending on the room temperature, indoor unit will automatically operate in either the cooling or heating mode and keep the room temperature within the preset range. The set temperatures that are specified for the Cool/Dry mode and the Heat mode will be used to automatically control the room temperature to stay within the set temperatures. This mode is especially effective during the in-between seasons, when the temperature difference between the highest and the lowest is large and both heating and cooling modes are used within the same day.

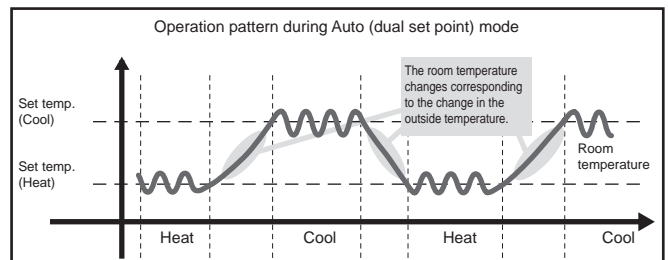

Auto (Single set point) mode (PEFY-P-VMHS-E-F series)

In the single set point mode, the set temperatures for cooling and heating are used in common. Cooling operation starts when the outdoor temperature is higher than the set temperature, and heating operation starts when the outdoor temperature is lower than the set temperature.

During Auto operation, the unit operation switches to the cooling operation when the outdoor temperature keeps higher than the set temperature by 1.5°C or more for consecutive periods of three minutes.

In the same way, the unit operation switches to the heating operation when the outdoor temperature keeps lower than the set temperature by 1.5°C or more for consecutive periods of three minutes.

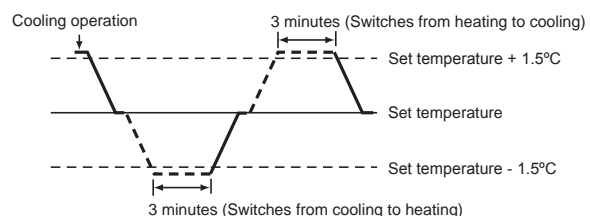

3.3. Set temperature

<Cool, Dry, Heat, and Auto (single set point)>

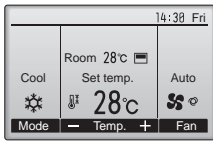

Press the [F2] button to decrease the set temperature, and press the [F3] button to increase.

* Refer to the table below for the settable temperature range for different operation modes.

* Set temperature cannot be set for the Fan mode.

* Depending on the Temperature unit setting, temperatures will decrease or increase by 0.5°C, 1°C, 1°F, or 2°F increments.

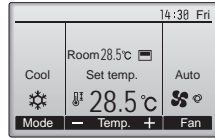
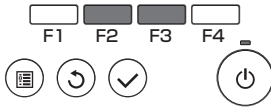

Example display
(Centigrade in 0.5-degree increments)

<Auto (dual set point) mode>

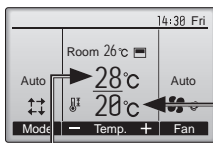

The current set temperatures will appear. Press the [F2] or [F3] button to display the Settings screen.

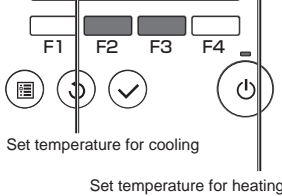

Set temperature range

[Models other than PEFY-P-VMHS-E-F]

Operation mode	Set temperature range
Cool/Dry	19°C–30°C/67°F–87°F *1
Heat	17°C–28°C/63°F–83°F *1
Auto (single set point)	19°C–28°C/67°F–83°F *1*2
Auto (dual set points)	Cool: Same as the set temperature range for Cool mode Heat: Same as the set temperature range for Heat mode *2*3*4
Fan	Not settable

*1 The settable temperature ranges vary, depending on the indoor unit model.

*2 The set temperature for Auto mode (either single or dual set point(s)) will appear depending on the indoor unit model.

*3 The same values are used for the set temperature for Cool/Dry mode and the cooling set temperature for Auto mode (dual set points). Likewise, the same values are used for the set temperature for Heat mode and the heating set temperature for Auto mode (dual set points).

*4 The cooling and heating set temperatures can be set under the following conditions.
- The cooling set temperature is greater than the heating set temperature.
- The difference between the cooling and heating set temperatures is equal or greater than the minimum temperature difference that varies with the indoor unit model.

[PEFY-P-VMHS-E-F series]

Operation mode	Set temperature range
Cool	14°C–30°C
Heat	17°C–28°C
Auto (single set point)	17°C–28°C
Fan	Not settable

3.4. Fan speed

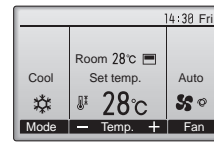

Press the [F4] button to go through the fan speeds in the following order.

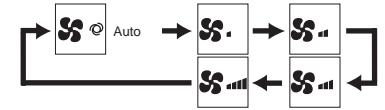
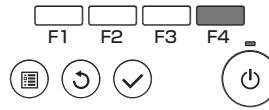

• The number of available fan speeds depends on the indoor unit model.

[PEFY-P200-250VMH, PEFY-P-VMH-E-F series]

* Switching of fan speed is impossible.

[PEFY-P40~140VMH, PFFY-P-VLEM, PFFY-P-VLRM series]

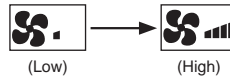

[PLFY-P125VLMDD]

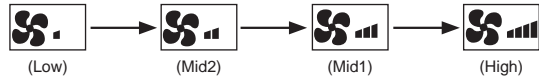

[PLFY-P20~100VLMDD, PEFY-P-VMR, PEFY-P-VMHS-E-F series]

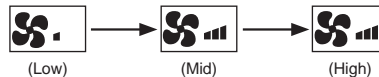

[PFFY-P-VLRMM-E, PEFY-P-VMA(L)-E, PEFY-P-VMHS-E series]

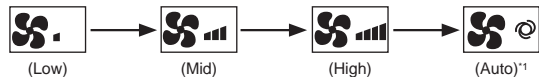

*1 This setting can be adjusted only with MA remote controller.

• The actual fan speed will differ from the fan speed displayed on the LCD when one of the following conditions is met.

1. While "STAND BY" or "DEFROST" is displayed
2. When the room temperature is higher than the set temperature during the heating mode
3. Immediately after the heating operation (during stand by for switching the operation mode)
4. During the Dry mode

3.5. Vane/Ventilation (Lossnay)

Accessing the menu

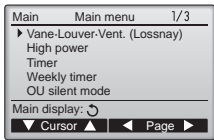

Select "Vane+Louver+Vent. (Lossnay)" from the Main menu, and press the [SELECT] button.

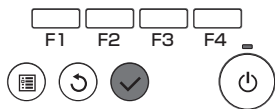

Vane setting

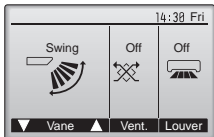

Press the [F1] or [F2] button to go through the vane setting options: "Auto," "Step 1," "Step 2," "Step 3," "Step 4," "Step 5," and "Swing."

Select the desired setting.

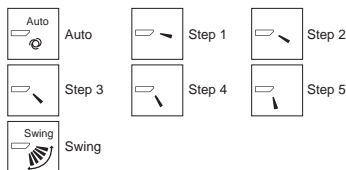

Select "Swing" to move the vanes up and down automatically. When set to "Step 1" through "Step 5", the vane will be fixed at the selected angle. * Some models of indoor units are not equipped with vanes.

* **1h** under the vane setting icon
This icon will appear when the vane is set to "Step 5" and the fan operates at low speed during cooling or dry operation (depending on the indoor unit model). The icon will go off in an hour, and the vane setting will automatically change.

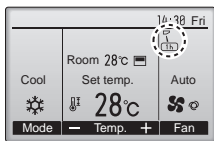

- The actual vane position will differ from the vane position displayed on the LCD when one of the following conditions is met.
 - While "STAND BY" or "DEFROST" is displayed
 - Immediately after the heating operation
 - During Thermo-OFF in the heating mode

[PPFY-P-VLEM]

While pulling the blowout grill out toward you, raise the rear, remove it, change the direction, and set it in place.

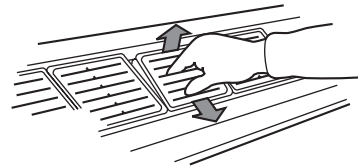

⚠ Caution:

- Avoid putting your hand into the air outlet of the indoor unit any more than necessary. If you get your hands caught in the metal parts when adjusting the airflow-direction-adjustment board and blowout grill, or nip them in the autovane, there is a risk of injury and failure.

Ventilation setting

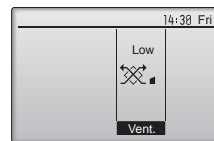

Press the [F3] button to go through the ventilation setting options in the order of "Off," "Low," and "High."

* Settable only when LOSSNAY unit is connected.

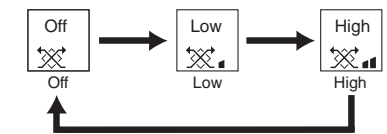
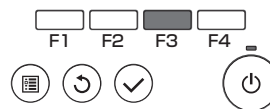

* The fan on some models of indoor units may be interlocked with certain models of ventilation units.

4. The smart way to use

Even minimal steps to care for your air conditioner can help make its use far more effective in terms of air-conditioning effect, electricity charges, etc.

Set the right room temperature

- In cooling operation, a temperature difference of about 5°C between indoors and outdoors is optimum.
- If the room temperature is raised by 1°C during air-cooling operation, about 10% electric power can be saved.
- Excessive cooling is bad for health. It also results in the waste of electric power.

Clean the filter thoroughly

- If the screen of the air filter becomes clogged, the airflow and air-conditioning effect can be significantly reduced. Further, if the condition is left unattended, failure can result. It is particularly important to clean the filter at the beginning of the cooling and heating seasons. (When profuse dust and dirt have accumulated, clean the filter thoroughly.)

5. Caring for the machine

Always have filter maintenance performed by a service person. Before care-taking, turn the power supply OFF.

⚠ Caution:

- Before you start cleaning, stop operation and turn OFF the power supply. Remember that the fan is rotating inside at high speed, posing a serious risk of injury.
- Indoor units are equipped with filters to remove the dust of sucked-in air. Clean the filters following the procedures on the right. (The standard filter should normally be cleaned once a week, and the long-life filter at the beginning of each season.)
- The life of the filter depends on where the unit is installed and how it is operated.

Prevent intrusion of heat during air-cooling

- To prevent the intrusion of heat during cooling operation, provide a curtain or a blind on the window to block out direct sunlight. Also, do not open the entrance or exit except in cases of dire necessity.

Carry out ventilation sometimes

- Since the air periodically gets dirty in a room that is kept closed for a long time, ventilation is sometimes necessary. When gas appliances are used together with the air conditioner, special precautions must be taken. If the "LOSSNAY" ventilation unit developed by our company is used, you can perform ventilation with less waste. For details on this unit, consult with your dealer.

How to clean

- Clear dust away lightly or clean it up with a vacuum cleaner. In the case of severe staining, wash the filter in lukewarm water mixed with dissolved neutral detergent or water, and then rinse off the detergent completely. After washing, dry it and fix it back into place.

⚠ Caution:

- Do not dry the filter by exposing it to direct sunlight or warming it using fire, etc. Doing so can result in the deformation of the filter.
- Washing it in hot water (more than 50°C) can also result in deformation.
- Never pour water or flammable sprays onto the air conditioner. Cleaning using these methods can result in the failure of the air conditioner, electric shock, or fire.

6. Troubleshooting

**When an error occurs, the following screen will appear.
Check the error status, stop the operation, and consult your dealer.**

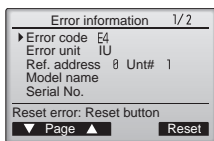

Error code, error unit, refrigerant address, unit model name, and serial number will appear.
The model name and serial number will appear only if the information have been registered.

Press the [F1] or [F2] button to go to the next page.

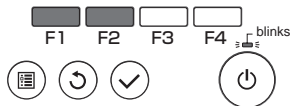

Before you ask for repair service, check the following points:

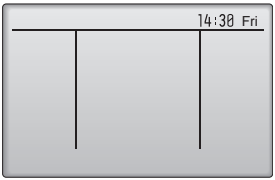
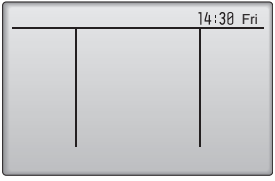
State of Machine	Remote Controller	Cause	Troubleshooting
It does not run.	Ruled line and clock are not displayed. No display appears even when the [ON/OFF] button is pressed.	Power failure	Press the [ON/OFF] button after power restoration.
		The power supply is turned OFF.	Turn the power supply ON.
		The fuse in the power supply is gone.	Replace fuse.
		The earth leakage breaker is gone.	Put in the earth leakage breaker.
Air flows out but it does not cool enough or heat enough.	The liquid crystal display shows that it is in the state of operation.	Improper temperature adjustment	After checking the set temperature and inlet temperature on the liquid crystal display, refer to section 3.3 "Set temperature", and operate the adjustment button.
		The filter is filled with dust and dirt.	Clean up the filter. (Refer to section 5 "Caring for the machine".)
		There are some obstacles at the air inlet and outlet of the indoor and outdoor units.	Remove.
		Windows and doors are open.	Close.
Cool air or warm air does not come out.	The liquid crystal display shows that it is in operation.	The restart-preventing circuit is in operation for 3 minutes.	Wait for a while. (To protect the compressor, a 3- minute restart-preventing circuit is built into the indoor unit. Therefore, there are occasions sometimes when the compressor does not start running immediately. There are cases when it does not run for as long as 3 minutes.)
		Indoor unit operation was restarted during the heating and defrosting operation.	Wait for a while. (Heating operation starts after ending defrosting operation.)
It runs briefly, but soon stops.	The "CHECK" and check code flash on the liquid crystal display.	There are some obstacles at the air inlet and outlet of the indoor and outdoor units.	Rerun after removal
		The filter is filled with dust and dirt.	Rerun after cleaning the filter. (Refer to section 5 "Caring for the machine".)
The sound of the exhaust and rotation of the motor can still be heard after stop of running.	All lights are out except the ruled line and clock. 	When other indoor units are engaged in cooling operation, the machine stops after running a drain-up mechanism for 3 minutes when air-cooling operation is stopped.	Wait for 3 minutes.
The sound of the exhaust and the rotation of the motor can be heard intermittently after stop of running.	All lights are out except the ruled line and clock. 	When other indoor units are engaged in cooling operation, drained water is brought in. If the drain water is collected, the drain-up mechanism initiates a draining operation.	It soon stops. (If the noise occurs more than 2-3 times in an hour, ask for repair service.)
Warm air comes out intermittently when the thermostat is OFF or during fan operation.	The liquid crystal display shows that it is in the state of operation.	When other indoor units are engaged in heating operation, the control valves are opened and closed from time to time to maintain the stability of the system.	It soon stops. (If the room temperature rises uncomfortably high in a small room, stop operation.)

• If operation stops due to a power failure, the [restart-preventing circuit at power failure] operates and disables unit operation even after power restoration. In this case, press the [ON/OFF] button again and start operation.

If malfunctions persist after you have checked the above, turn the power supply OFF and contact your dealer with information about the product name, the nature of the malfunction, etc. If the display of error information flashes, tell the dealer contents of the display (error code). Never attempt to repair by yourself.

The following symptoms are not air conditioner failures:

- The air blown out from the air conditioner can sometimes give off odors. This is due to cigarette smoke contained in the air of the room, the smell of cosmetics, the walls, furniture, etc., absorbed in the air conditioner.
- A hissing noise can be heard immediately after the air conditioner is started or stopped. This is the sound of the refrigeration flowing inside the air conditioner. This is normal.
- The air conditioner sometimes snaps or clicks at the beginning or end of

cooling/heating operation. This is the sound of friction on the front panel and other sections due to expansion and contraction caused by temperature change. This is normal.

- The fan speed changes in spite of not changing the setting. Not to blow out cold air at the beginning of heating operation, the air conditioner automatically adjusts the fan speed gradually from lower to the set speed. It also adjust its fan speed to protect the fan motor when return air temperature or fan speed excessively rises.

7. Installation, transferring works, and checking

Regarding place for installation

Consult with your dealer for details on installation and transferring the installation.

Caution:

- **Never install the air conditioner where there is a risk of leakage of flammable gas. If gas leaks and accumulates around the unit, fire can result.**
- **Never install the air conditioner at the following place:**
 - where there is a lot of machine oil
 - near the ocean and beach areas where there is salt air.
 - where humidity is high
 - where there are hot springs nearby
 - where there is sulphurous gas
 - where there is a high-frequency processing machinery (a high-frequency welder, etc.)
 - where acid solution is frequently used
 - where special sprays are frequently used.
- **Install the indoor unit horizontally. Otherwise, water leakage can result.**
- **Take sufficient measures against noise when installing the air conditioners at hospitals or communication-related businesses.**

If the air conditioner is used in any of the above-mentioned environments, frequent operational failure can be expected. It is advisable to avoid these types of installation sites.

For further details, consult with your dealer.

Regarding electrical work

Caution:

- **The electrical work must be undertaken by a person who is qualified as an electrical engineer according to the [technical standard respecting electrical installation], [internal wiring rules], and the installation instruction manual with the absolute use of exclusive circuits. The use of other products with the power source can result in burnt-out breakers and fuses.**
- **Never connect the grounding wire to a gas pipe, water pipe, arrester, or telephone grounding wire. For details, consult with your dealer.**
- **In some types of installation sites, the installation of an earth leakage breaker is mandatory. For details, consult with your dealer.**

Regarding transfer of installation

- When removing and reinstalling the air conditioner when you enlarge your home, remodel, or move, consult with your dealer in advance to ascertain the cost of the professional engineering work required for transferring the installation.

Caution:

- **When moving or reinstalling the air conditioner, consult with your dealer. Defective installation can result in electric shock, fire, etc.**

Regarding noise

- In installing work, choose a place that can fully bear the weight of the air conditioner, and where noise and vibration can be reduced.
- Choose a place where cool or warm air and noise from the outdoor air outlet of the air conditioner does not inconvenience the neighbors.
- If any alien object is placed near the outdoor air outlet of the air conditioner, decreased performance and increased noise can result. Avoid placing any obstacles adjacent to the air outlet.
- If the air conditioner produces any abnormal sound, consult with your dealer.

Maintenance and inspection

- If the air conditioner is used throughout several seasons, the insides can get dirty, reducing the performance. Depending upon the conditions of usage, foul odors can be generated and drainage can deteriorate due to dust and dirt, etc.

8. Specifications

PLFY-P-VLMD-E series

		P20VLMD-E	P25VLMD-E	P32VLMD-E	P40VLMD-E	P50VLMD-E	P63VLMD-E
Power source		~220-240 V 50 Hz/~220-230 V 60 Hz					
Cooling capacity*1/Heating capacity*1		kW	2.2/2.5	2.8/3.2	3.6/4.0	4.5/5.0	5.6/6.3
Dimension*2	Height	mm	290 (20)	290 (20)	290 (20)	290 (20)	290 (20)
	Width	mm	776 (1080)	776 (1080)	776 (1080)	776 (1080)	946 (1250)
	Depth	mm	634 (710)	634 (710)	634 (710)	634 (710)	634 (710)
Net weight		kg	23 (6.5)	23 (6.5)	24 (6.5)	24 (6.5)	27 (7.5)
Fan	Airflow rate (Low-Middle-High)	m ³ /min	6.5-8.0-9.5	6.5-8.0-9.5	6.5-8.0-9.5	7.0-8.5-10.5	9.0-11.0-12.5
Sound pressure level (Low-Middle-High)*3	dB(A)	220, 240 V	27-30-33	27-30-33	27-30-33	29-33-36	31-34-37
		230 V	28-31-34	28-31-34	28-31-34	30-34-37	32-35-38
Filter		Long life filter					

		P80VLMD-E	P100VLMD-E	P125VLMD-E
Power source		~220-240 V 50 Hz/~220-230 V 60 Hz		
Cooling capacity*1/Heating capacity*1		kW	9.0/10.0	11.2/12.5
Dimension*2	Height	mm	290 (20)	290 (20)
	Width	mm	1446 (1750)	1446 (1750)
	Depth	mm	634 (710)	634 (710)
Net weight		kg	44 (12.5)	47 (12.5)
Fan	Airflow rate (Low-Middle-High)	m ³ /min	15.5-18.5-22.0	17.5-21.0-25.0
Sound pressure level (Low-Middle-High)*3	dB(A)	220, 240 V	33-36-39	36-39-42
		230 V	34-37-40	37-41-43
Filter		Long life filter		

* Operation temperature of indoor unit
Cooling mode: 15°CWB - 24°CWB
Heating mode: 15°CDB - 27°CDB

*1 Cooling/Heating capacity indicates the maximum value at operation under the following condition.
<Cooling> Indoor: 27°CDB/19°CWB, Outdoor: 35°CDB
<Heating> Indoor: 20°CDB, Outdoor: 7°CDB/6°CWB

*2 The figure in () indicates panel's.

*3 The operating noise is the data that was obtained in an anechoic room.

PEFY-P-VMH-E series

		P40VMH-E	P50VMH-E	P63VMH-E	P71VMH-E	P80VMH-E
Power source		~220-240 V 50/60 Hz				
Cooling capacity*/Heating capacity* ¹	kW	4.5/5.0	5.6/6.3	7.1/8.0	8.0/9.0	9.0/10.0
Dimension (Height/Width/Depth)	mm	380/750/900	380/750/900	380/750/900	380/1000/900	380/1000/900
Net weight	kg	41	41	41	50	50
Fan	Airflow rate (Low-High)	m ³ /min 10.0-14.0		13.5-19.0	15.5-22.0	18.0-25.0
	External static pressure* ²	Pa	Pa	Pa	Pa	Pa
		220 V	50/100/200	50/100/200	50/100/200	50/100/200
		230, 240 V	100/150/200	100/150/200	100/150/200	100/150/200
Sound pressure level (Low-High) ⁵	dB(A)	220 V	27-34	27-34	32-38	35-41
		230, 240 V	31-37	31-37	36-41	38-43
Filter	Long life filter (option)					

		P100VMH-E	P125VMH-E	P140VMH-E
Power source		~220-240 V 50/60 Hz		
Cooling capacity*/Heating capacity* ¹	kW	11.2/12.5	14.0/16.0	16.0/18.0
Dimension (Height/Width/Depth)	mm	380/1200/900	380/1200/900	380/1200/900
Net weight	kg	65	65	67
Fan	Airflow rate (Low-High)	m ³ /min 26.5-38.0		28.0-40.0
	External static pressure* ²	Pa	Pa	Pa
		220 V	50/100/200	50/100/200
		230, 240 V	100/150/200	100/150/200
Sound pressure level (Low-High) ⁵	dB(A)	220 V	34-42	34-42
		230, 240 V	38-44	38-44
Filter	Long life filter (option)			

		P200VMH-E	P250VMH-E
Power source		3 N ~380-415 V 50/60 Hz	
Cooling capacity*/Heating capacity* ¹	kW	22.4/25.0	28.0/31.5
Dimension (Height/Width/Depth)	mm	470/1250/1120	470/1250/1120
Net weight	kg	100	100
Fan	Airflow rate	m ³ /min 58.0	
	External static pressure* ³	Pa	Pa
		380 V	110/220
		400, 415 V	130/260
Sound pressure level ⁵	dB(A)	380 V	42
		400, 415 V	50
Filter	Long life filter (option)		

PEFY-P-VMHS-E series

		P200VMHS-E	P250VMHS-E
Power source		~220-240 V 50/60 Hz	
Cooling capacity*/Heating capacity* ¹	kW	22.4/25.0	28.0/31.5
Dimension (Height/Width/Depth)	mm	470/1250/1120	470/1250/1120
Net weight	kg	97	100
Fan	Airflow rate (Low-Middle-High)	m ³ /min 50.0-61.0-72.0	
	External static pressure* ⁴	Pa 50/100/150/200/250	
Sound pressure level (Low-Middle-High) ⁵	dB(A)	36-39-43	39-42-46
Filter	Long life filter (option)		

* Operation temperature of indoor unit
Cooling mode: 15°CWB - 24°CWB
Heating mode: 15°CDB - 27°CDB

*¹ Cooling/Heating capacity indicates the maximum value at operation under the following condition.
<Cooling> Indoor: 27°CDB/19°CWB, Outdoor: 35°CDB
<Heating> Indoor: 20°CDB, Outdoor: 7°CDB/6°CWB

*² The external static pressure is set to 100 Pa (at 220 V)/150 Pa (at 230, 240 V) at factory shipment.

*³ The external static pressure is set to 220 Pa (at 380 V)/260 Pa (at 400, 415 V) at factory shipment.

*⁴ The external static pressure is set to 150 Pa at factory shipment.

*⁵ The operating noise is the data that was obtained in an anechoic room.

PEFY-P-VMH-E-F series

		P80VMH-E-F	P140VMH-E-F	
Power source		~220-240 V 50 Hz/~208-230 V 60 Hz		
Cooling capacity ^{*1} /Heating capacity ^{*1}		kW	9.0/8.5 16.0/15.1	
Dimension (Height/Width/Depth)		mm	380/1000/900 380/1200/900	
Net weight		kg	50 67	
Fan	Airflow rate (High)	m ³ /min	9 18	
	External static pressure	Pa	220 V 50 Hz	40/115/190 50/115/190
			230 V 50 Hz	50/130/210 60/130/220
			240 V 50 Hz	80/170/220 100/170/240
			208 V 60 Hz	35/85/170 35/85/170
			220 V 60 Hz	40/115/190 50/115/190
230 V 60 Hz			50/130/220 60/130/220	
Sound pressure level (High) ^{*2}	dB(A)	208, 220 V	27/83/43 28/38/43	
		230, 240 V	33/43/45 34/43/45	
Filter		Long life filter (option)		

		P200VMH-E-F	P250VMH-E-F	
Power source		3 N ~380-415 V 50/60 Hz		
Cooling capacity ^{*1} /Heating capacity ^{*1}		kW	22.4/21.2 28.0/26.5	
Dimension (Height/Width/Depth)		mm	470/1250/1120 470/1250/1120	
Net weight		kg	100 100	
Fan	Airflow rate	m ³ /min	28 35	
	External static pressure	Pa	380 V	140/200 110/190
			400 V	150/210 120/200
			415 V	160/220 130/210
380 V			39/42 40/44	
Sound pressure level	dB(A)	400 V	40/43 40/45	
		415 V	40/44 41/46	
		415 V	40/44 41/46	
Filter		Long life filter (option)		

*1 Cooling/Heating capacity indicates the maximum value at operation under the following condition.

<Cooling> Indoor: 33°CDB/28°CWB, Outdoor: 33°CDB

<Heating> Indoor: 0°CDB/-2.9°CWB, Outdoor: 0°CDB/-2.9°CWB

*2 The operating noise is the data that was obtained in an anechoic room.

PEFY-P-VMHS-E-F series

		P125VMHS-E-F	P200VMHS-E-F	P250VMHS-E-F	
Power source		~220-240 V 50/60 Hz			
Cooling capacity ^{*1} /Heating capacity ^{*1}		kW	14.0/8.9 22.4/13.9 28.0/17.4		
Dimension (Height/Width/Depth)		mm	380/1200/900 470/1250/1120 470/1250/1120		
Net weight		kg	46 79 82		
Fan	Airflow rate (High)	m ³ /min	14.0-15.5-18.0-(20.0)	22.5-25.0-28.0-(32.0)	28.0-31.0-35.0-(40.0)
	External static pressure	Pa	100/150/200/250		
Sound pressure level (High) ^{*2}		dB(A)	34/37/41 35/38/41 38/40/44		
Filter		Long life filter (option)			

*1 Cooling/Heating capacity indicates the maximum value at operation under the following condition.

<Cooling> Indoor: 33°CDB/28°CWB, Outdoor: 33°CDB

<Heating> Indoor: 0°CDB/-2.9°CWB, Outdoor: 0°CDB/-2.9°CWB

*2 The operating noise is the data that was obtained in an anechoic room.

PFFY-P-VLEM-E/PFFY-P-VLRM(M)-E series

	P20VLEM-E	P25VLEM-E	P32VLEM-E	P40VLEM-E	P50VLEM-E	P63VLEM-E		
Power source	~220-240 V 50 Hz/~208-230 V 60 Hz							
Cooling capacity ^{*1} /Heating capacity ^{*1}	kW	2.2/2.5	2.8/3.2	3.6/4.0	4.5/5.0	5.6/6.3	7.1/8.0	
Dimension (Height/Width/Depth)	mm	630/1050/220	630/1050/220	630/1170/220	630/1170/220	630/1410/220	630/1410/220	
Net weight	kg	28	28	30	32	36	37	
Fan	Airflow rate (Low-High)	m ³ /min	5.5-6.5	5.5-6.5	7.0-9.0	9.0-11.0	12.0-14.0	12.0-15.5
Sound pressure level (Low-High) ^{*3 *4}	dB(A)	34-40	34-40	35-40	38-43	38-43	40-46	
Filter	Standard filter							

	P20VLRM-E	P25VLRM-E	P32VLRM-E	P40VLRM-E	P50VLRM-E	P63VLRM-E		
Power source	~220-240 V 50 Hz/~208-230 V 60 Hz							
Cooling capacity ^{*1} /Heating capacity ^{*1}	kW	2.2/2.5	2.8/3.2	3.6/4.0	4.5/5.0	5.6/6.3	7.1/8.0	
Dimension (Height/Width/Depth)	mm	639/886/220	639/886/220	639/1006/220	639/1006/220	639/1246/220	639/1246/220	
Net weight	kg	22	22	24	25	29	30	
Fan	Airflow rate (Low-High)	m ³ /min	5.5-6.5	5.5-6.5	7.0-9.0	9.0-11.0	12.0-14.0	12.0-15.5
Sound pressure level (Low-High) ^{*3 *4}	dB(A)	34-40	34-40	35-40	38-43	38-43	40-46	
Filter	Standard filter							

	P20VLRMM-E	P25VLRMM-E	P32VLRMM-E	P40VLRMM-E	P50VLRMM-E	P63VLRMM-E		
Power source	~220-240 V 50 Hz/60 Hz							
Cooling capacity ^{*1} /Heating capacity ^{*1}	kW	2.2/2.5	2.8/3.2	3.6/4.0	4.5/5.0	5.6/6.3	7.1/8.0	
Dimension (Height/Width/Depth)	mm	639/886/220	639/886/220	639/1006/220	639/1006/220	639/1246/220	639/1246/220	
Net weight	kg	21	21	24	25	29	29	
Fan	Airflow rate (Low-Middle-High)	m ³ /min	4.5-5.5-6.5	4.5-5.5-6.5	6.5-7.5-9.0	8.0-9.5-10.0	10.0-12.0-14.0	11.0-13.0-15.5
	External static pressure ^{*2}	Pa	20/40/60	20/40/60	20/40/60	20/40/60	20/40/60	
Sound pressure level (Low-Middle-High) ^{*2 *4}	dB(A)	31-36-40	31-36-40	27-32-37	30-36-40	32-37-41	35-40-44	
Filter	Standard filter							

* Operation temperature of indoor unit

Cooling mode: 15°CWB - 24°CWB

Heating mode: 15°CDB - 27°CDB

*1 Cooling/Heating capacity indicates the maximum value at operation under the following condition.

<Cooling> Indoor: 27°CDB/19°CWB, Outdoor: 35°CDB

<Heating> Indoor: 20°CDB, Outdoor: 7°CDB/6°CWB

*2 The external static pressure is set to 20 Pa at factory shipment.

*3 The figures represent a 240 V/50 Hz unit measured at a point which is 1 m away from the front of the unit and at a height of 1 m from the floor.

The noise is approximately 1 dB(A) less for a 230 V unit and approximately 2 dB(A) less for a 220 V unit. The noise is approximately 3 dB(A) less when the measurement point is 1.5 m away from the front of the unit and at a height of 1.5 m from the floor.

*4 The operating noise is the data that was obtained in an anechoic room.

PEFY-P-VMR-E-L/R series

		P20VMR-E-L/R	P25VMR-E-L/R	P32VMR-E-L/R	
Power source		~220-240 V 50 Hz/~220-230 V 60 Hz			
Cooling capacity ^{*1} /Heating capacity ^{*1}	kW	2.2/2.5	2.8/3.2	3.6/4.0	
Dimension (Height/Width/Depth)	mm	292/640/580	292/640/580	292/640/580	
Net weight	kg	18	18	18	
Fan	Airflow rate (Low-Middle-High)	m ³ /min	4.8/5.8/7.9	4.8/5.8/7.9	4.8/5.8/9.3
	External static pressure	Pa	5	5	5
Sound pressure level (Low-Middle-High) ^{*3}		dB(A)			
	220 V		20/25/30	20/25/30	20/25/33
	230 V		21/26/32	21/26/32	21/26/35
240 V		22/27/30	22/27/30	22/27/33	
Filter		Standard filter			

PEFY-P-VMA(L)-E series

		P20VMA(L)-E	P25VMA(L)-E	P32VMA(L)-E	P40VMA(L)-E	P50VMA(L)-E	
Power source		~220-240 V 50/60 Hz					
Cooling capacity ^{*1} /Heating capacity ^{*1}	kW	2.2/2.5	2.8/3.2	3.6/4.0	4.5/5.0	5.6/6.3	
Dimension (Height/Width/Depth)	mm	250/700/732	250/700/732	250/700/732	250/900/732	250/900/732	
Net weight	kg	23	23	23	26	26	
Fan	Airflow rate (Low-Middle-High)	m ³ /min	6.0-7.5-8.5	6.0-7.5-8.5	7.5-9.0-10.5	10.0-12.0-14.0	12.0-14.5-17.0
	External static pressure ^{*2}	Pa	35/50/70/100/150	35/50/70/100/150	35/50/70/100/150	35/50/70/100/150	35/50/70/100/150
Sound pressure level (Low-Middle-High) ^{*3}	(measurement condition 1)	dB(A)	23-25-26	23-25-26	23-26-29	23-27-30	25-29-32
	(measurement condition 2)	dB(A)	26-28-29	26-28-29	28-30-34	28-30-34	28-32-35
Filter		Standard filter					

		P63VMA(L)-E	P71VMA(L)-E	P80VMA(L)-E	
Power source		~220-240 V 50/60 Hz			
Cooling capacity ^{*1} /Heating capacity ^{*1}	kW	7.1/8.0	8.0/9.0	9.0/10.0	
Dimension (Height/Width/Depth)	mm	250/1100/732	250/1100/732	250/1100/732	
Net weight	kg	32	32	32	
Fan	Airflow rate (Low-Middle-High)	m ³ /min	13.5-16.0-19.0	14.5-18.0-21.0	14.5-18.0-21.0
	External static pressure ^{*2}	Pa	35/50/70/100/150	35/50/70/100/150	35/50/70/100/150
Sound pressure level (Low-Middle-High) ^{*3}	(measurement condition 1)	dB(A)	25-29-33	26-29-34	26-29-34
	(measurement condition 2)	dB(A)	29-32-36	30-34-38	30-34-38
Filter		Standard filter			

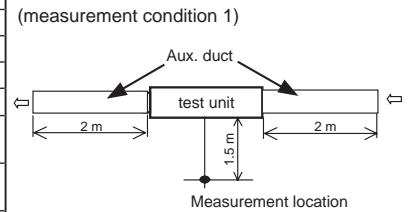

		P100VMA(L)-E	P125VMA(L)-E	P140VMA(L)-E	
Power source		~220-240 V 50/60 Hz			
Cooling capacity ^{*1} /Heating capacity ^{*1}	kW	11.2/12.5	14.0/16.0	16.0/18.0	
Dimension (Height/Width/Depth)	mm	250/1400/732	250/1400/732	250/1600/732	
Net weight	kg	42	42	46	
Fan	Airflow rate (Low-Middle-High)	m ³ /min	23.0-28.0-33.0	28.0-34.0-40.0	29.5-35.5-42.0
	External static pressure ^{*2}	Pa	35/50/70/100/150	35/50/70/100/150	35/50/70/100/150
Sound pressure level (Low-Middle-High) ^{*3}	(measurement condition 1)	dB(A)	28-33-37	32-36-40	33-37-42
	(measurement condition 2)	dB(A)	32-37-41	35-40-44	36-41-45
Filter		Standard filter			

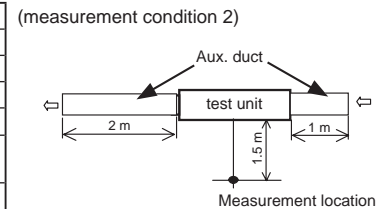

* Operation temperature of indoor unit
 Cooling mode: 15°CWB - 24°CWB
 Heating mode: 15°CDB - 27°CDB

*1 Cooling/Heating capacity indicates the maximum value at operation under the following condition.
 <Cooling> Indoor: 27°CDB/19°CWB, Outdoor: 35°CDB
 <Heating> Indoor: 20°CDB, Outdoor: 7°CDB/6°CWB

*2 The external static pressure is set to 50 Pa at factory shipment.

*3 The operating noise is the data that was obtained in an anechoic room.

This product is designed and intended for use in the residential,
commercial and light-industrial environment.

The product at hand is based on the following EU regulations:

- Low Voltage Directive 2014/35/EU
- Electromagnetic Compatibility Directive 2014/30/EU
- Machinery Directive 2006/42/EC

Please be sure to put the contact address/telephone number
on this manual before handing it to the customer.

MITSUBISHI ELECTRIC CORPORATION

HEAD OFFICE: TOKYO BLDG., 2-7-3, MARUNOUCHI, CHIYODA-KU, TOKYO 100-8310, JAPAN