

Lossnay

Models:

LGH-150RVXT-E

LGH-200RVXT-E

LGH-250RVXT-E

Operating Instructions

Lossnay Energy Recovery Ventilator

MODELS:

LGH-150RVXT-E

LGH-200RVXT-E

LGH-250RVXT-E

Operating Instructions

(For the user)







Please read this manual carefully before use for proper and safe use.

Do not attempt to install the product by yourself.



Safety precautions

The following signs indicate that death or serious injury may be caused by failure to heed the precautions described below.

WARNING

| | | | |
|---|---|---|---|
|  Prohibited | Do not turn the unit on or off when flammable gas has leaked. (It could catch fire or cause explosion with sparks released from electric contractor.) Open windows to ventilate. |  Wet hands prohibited | Do not operate with wet hands. (Electrical shock can result.) |
|  Do not disassemble | Do not modify or disassemble. (It could cause fire, electric shock or injury.) |  The instructions given must be followed. | Use the specified power supply and voltage. (Use of incorrect power supply could cause fire or electric shock.) Make sure the power supply isolator is turned off on the power distribution panel before starting maintenance. (It could cause electric shock or injury if it is turned on.) When any abnormal conditions (burning smell, or others) are observed, stop operation, turn off the power supply isolator on the power distribution panel and consult your dealer. (Continuing operation under such conditions could cause, electric shock, fire, or damage.) |
|  Do not wet | Do not apply water to the unit and remote controller. (Electrical shock can result.) | | |
|  Do not touch | Do not poke your fingers or sticks into the air intake and outlet while the product is operating. (Failure to heed this warning may result in injury.) | | |

CAUTION

| | | | |
|---|---|---|---|
|  Prohibited | Do not place a burning appliance in a place where it is exposed directly to the wind from Lossnay. (It could cause an accident as a result of incomplete combustion.) Do not operate with the "BY-PASS" when heating the room in winter. (Condensed water may drip from the unit and wet the surface of ceiling.) Do not use at a place where exposed to high temperatures (40°C or higher), naked flames, or in environment with heavy fumes. (It could cause fire.) Do not use in an environment such as a chemical factory, where hazardous gases such as acidic gases, alkaline gases, organic solvent fumes, paint fumes, or gases containing corrosive components are generated. (It could malfunction.) |  The instructions given must be followed. | Securely install parts after maintenance. (It could cause injury if parts fall.) Put on gloves during maintenance. (It could cause injury.) Make sure the power supply isolator is turned off on the power distribution panel when Lossnay is not used for a long period of time. (It could cause electric shock, power leakage, or fire as a result of deteriorated insulation.) This appliance is not intended for use by persons (including children) with reduced physical sensory or mental capabilities, or lack of experience and knowledge, unless they have been given supervision or instruction concerning use of the appliance by a person responsible for their safety. Children should be supervised to ensure that they do not play with the appliance. (This appliance can be used by children aged from 8 years and above and persons with reduced physical, sensory or mental capabilities or lack of experience and knowledge if they have been given supervision or instruction concerning use of the appliance in a safe way and understand the hazards involved. Children shall not play with the appliance. Cleaning and user maintenance shall not be made by children without supervision.) |
|---|---|---|---|

Names of the parts

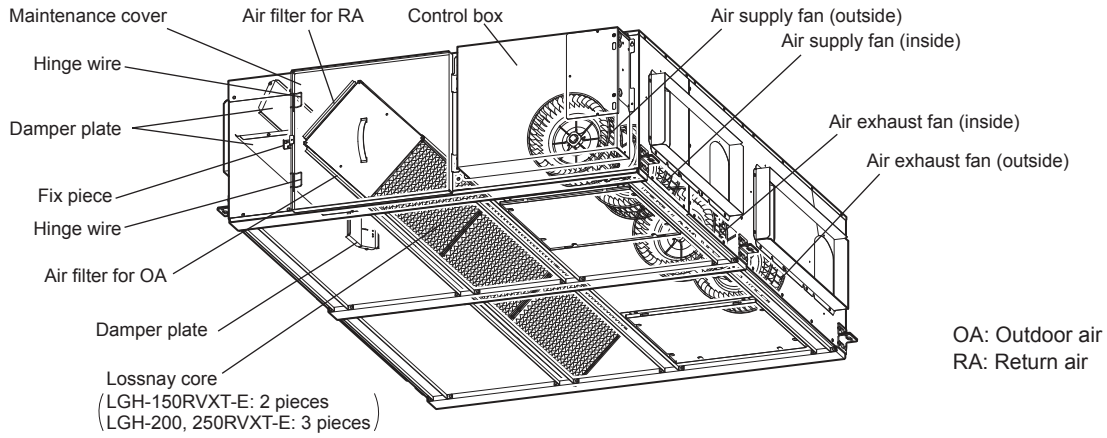

Operation

Lossnay can be connected with Lossnay remote controller (PZ-61DR-E), and other Systems (City Multi, Mr.Slim, Central controller (MELANS))

Following shows the use of PZ-61DR-E. Please refer to the manuals for the other systems.

For connection of a Lossnay remote controller (PZ-61DR-E)

If the Lossnay's operation is linked with the operation of an external device such as an air conditioner, the method of use will differ, so carry out the appropriate operation in accordance with the following table. Also, please see the installation and user manual for the Lossnay remote controller (PZ-61DR-E).

<Not connected to an external device>

| Example of System | Operation | Function |
|-------------------|----------------------------------|---|
| | Run using the remote controller. | <ul style="list-style-type: none"> If 2 remote controllers are used, the last controller to be used has priority. (Last Command) |

<Connected to an external device>

| | | |
|--|--|---|
| | If an external device is connected the "On/Off" function of this device, it will also control the Lossnay operation. | <ul style="list-style-type: none"> If you would like to turn ON the Lossnay alone while the external device is OFF, operate it by the Lossnay remote controller. |
| | | |

■ Display and Function button (PZ-61DR-E)

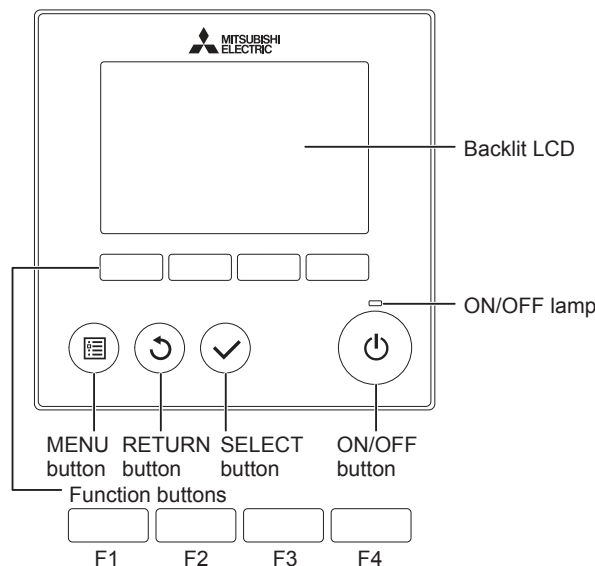

Operation (continued)

■ AUTOMATIC VENTILATION setting

The automatic ventilation mode automatically provides the correct ventilation for the conditions in the room. The following shows the effect "By-pass" ventilation will have under various conditions.

1. Reduces cooling load

If the air outside is cooler than the air inside the building during the cooling season (such as early morning or at night), "By-pass" ventilation will draw in the cooler outside air and reduce the cooling load on the system.

2. Night purge

"By-pass" ventilation can be used to release hot air from inside the building that has accumulated in buildings a business district during the hot summer season.

3. Office equipment room cooling

During cold season, fresh air can be drawn in and used as is to cool rooms where the temperature has risen due to the use of office equipment.

⚠ CAUTION

- In the case of "By-pass" ventilation, the supply air temperature slightly rises more than the outside air temperature because of the heat effect around the ducts or the unit motors.
- When set to auto ventilation mode while using the pre-heater function, the outdoor temperature may be detected as higher and the mode may change to by-pass mode, even in winter.

Maintenance

Remove all dust and dirt on air filters and Lossnay cores at regular intervals in order to prevent a deterioration in the Lossnay functions.

Guideline: Clean the air filters once a year.

(or when  are indicated on the remote controller)

Clean the Lossnay cores once two year.

(Clean the Lossnay cores once a year if possible.)

(Frequency should be increased depending on the extent of dirt.)

Removing the parts

1) Maintenance cover

1. Remove the black screw.
2. Slide the fix piece to out side.
3. Open hinge wire.

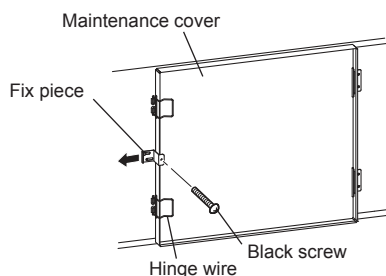

2) Air filters and Lossnay cores

1. Remove the front filters from the main unit.

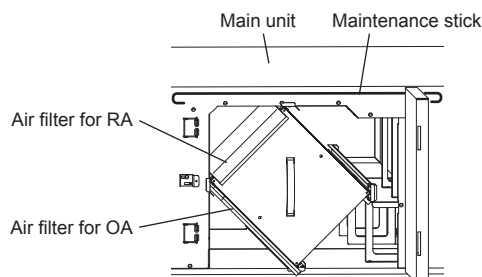

2. Hold the handle and draw the Lossnay cores out from the main unit.

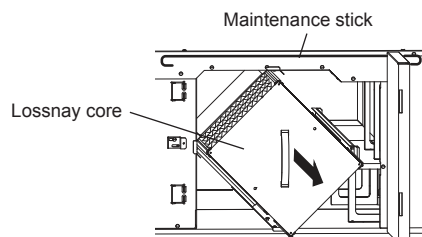

3. For LGH-200RVXT-E and LGH-250RVXT-E, use the maintenance stick attached to remove the third Lossnay cores.

| Model | Number of cores | Number of filters |
|---------------|-----------------|-------------------|
| LGH-150RVXT-E | 2 | 4 |
| LGH-200RVXT-E | 3 | 4 |
| LGH-250RVXT-E | 3 | 4 |

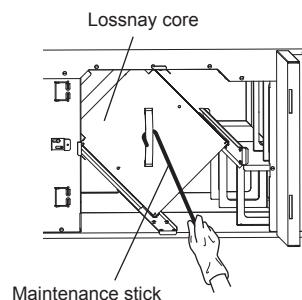

Cleaning the parts

1) Air filters

Use a vacuum cleaner to remove light dust. To remove stubborn dirt wash in a mild solution of detergent and lukewarm water. (under 40°C)

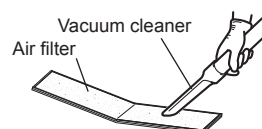

⚠ CAUTION

- Never wash the filters in very hot water and never wash them by rubbing them.
- Do not dry the filters by exposing them to a flame.

2) Lossnay cores

Use a vacuum cleaner to suck up the dust and dirt on the exposed surfaces of the Lossnay cores. Use a soft brush only to clean exposed surface areas.

Do NOT wash in water.

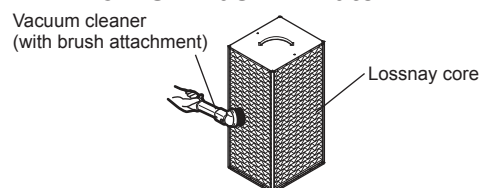

⚠ CAUTION

- Do not use the hard nozzle of the vacuum cleaner. It may damage the exposed surfaces of the Lossnay cores.
- Under no circumstances should the Lossnay cores be washed in water.

Maintenance (continued)

Assembly after maintenance

Bearing in mind the following points, assemble the parts following the sequence for their removal in reverse.

- Arrange the Lossnay core with the air filter side downward.
- Filter have front and back side. Set the correct side of the filter according to the arrow on the filter frame.

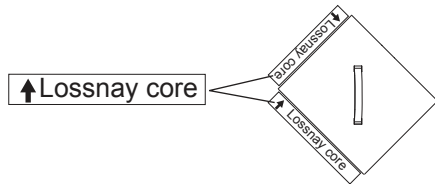

- Note the difference of filter height between outdoor air filter and return air filter.

Air filter for OA



Air filter for RA



Unit: mm

Note:

- If  are indicated on the remote controller, turn off the indication, after maintenance.

Specifications

| Model name | Running current (A) | Input power (W) | Air volume | | Static pressure | | Exchange efficiency (%) | | | Noise (dB) | Weight (kg) |
|---------------|---------------------|-----------------|---------------------|-------|-----------------|--------------|-------------------------|----------|---------|------------|-------------|
| | | | (m ³ /h) | (L/S) | Supply (Pa) | Exhaust (Pa) | Temperature | Enthalpy | | | |
| | | | | | | | | Heating | Cooling | | |
| LGH-150RVXT-E | 4.3 | 792 | 1500 | 417 | 175 | 100 | 80 | 70 | 69 | 39.5 | 156 |
| LGH-200RVXT-E | 5.4 | 1000 | 2000 | 556 | 175 | 100 | 80 | 72.5 | 70 | 39.5 | 159 |
| LGH-250RVXT-E | 7.6 | 1446 | 2500 | 694 | 175 | 100 | 77 | 68 | 65.5 | 43.0 | 198 |

- * The above values apply during Lossnay ventilation when the fan speed is set to Fan speed 4 at the rating pressure loss and 230 V / 50 Hz.
- * For the specifications at the other frequency or voltages, contact your dealer.
- * The values given in the table for the noise level reflect the levels measured at a position 1.5 meters immediately below the unit in an anechoic chamber.
- * Noise change or increase may occur because of the Bypass-Automatic function or Automatic fan speed change by timer setting and/or other functions.
- * Temperature Exchange efficiency (%) are based on winter condition.
- * Mitsubishi Electric measures products according to Japan Industrial Standard (JIS B 8628), therefore P-Q curves are measured by chamber method.
- * On-site commissioning measurements by pitot tube method could be as much 20% difference from JIS test room conditions. If the measuring point is close to sources of turbulence like bends, contractions and dampers etc, it is difficult to measure air volume correctly. A straight duct length more than 10D (D=duct diameter or equivalent) from the source of turbulence is recommended for correct measurement. On-site measurement should therefore be measured in accordance with BSRIA guideline (Commissioning Air System. Application procedures for buildings AG3/89.3(2001))

Maintenance and lifetime

The parts listed below are service parts. It is necessary that the regular check and the regular replacement or the replacement when it is broken. In addition, expenses for parts and replacement work is charged to customers.

- Motor
- Printed circuit board
- Lossnay core (Around 10 years with maintenance at stated periods.)
- Air filter (Around 5 years with maintenance at stated periods)

After-sales servicing

Consult with your dealer about the after-sales services provided for this Lossnay product.

If you hear strange sounds, if no air is blown out or if some other trouble occurs, switch off the power and contact your dealer. Consult with your dealer concerning the cost of inspection or repair work.

| | | |
|--|---|--|
| <p>Attentive inspection</p>  | <p>Inspect your unit of good service!</p> <p>Have you noticed?</p> <ul style="list-style-type: none"> ● Fan do not run when the unit is turned on. ● Abnormal noises or vibrations while the unit is running. ● Retarded or irregular rotations. (Motors are component which requires maintenance.) ● Burnt odor. ● Corroded or damaged installation section. | <div style="display: flex; align-items: center; justify-content: center;"> <div style="background-color: black; color: white; padding: 10px; margin-right: 10px;"> <p>Stop running.</p> </div> <div style="font-size: 2em;">▶</div> </div> <p>Turn off the unit. Then, contact your dealer for prevention of failure or hazard. The dealer should appraise the possible cost.</p> |
|--|---|--|

mitsubishi electric corporation

Manufactured by: MITSUBISHI ELECTRIC CORPORATION

TOKYO BLDG. 2-7-3, MARUNOUCHI, CHIYODA-KU, TOKYO, 100-8310 JAPAN

Importer in EU: MITSUBISHI ELECTRIC EUROPE B.V.

HARMAN HOUSE, 1 GEORGE STREET, UXBRIDGE, MIDDLESEX, UB8 1QQ, U.K.