

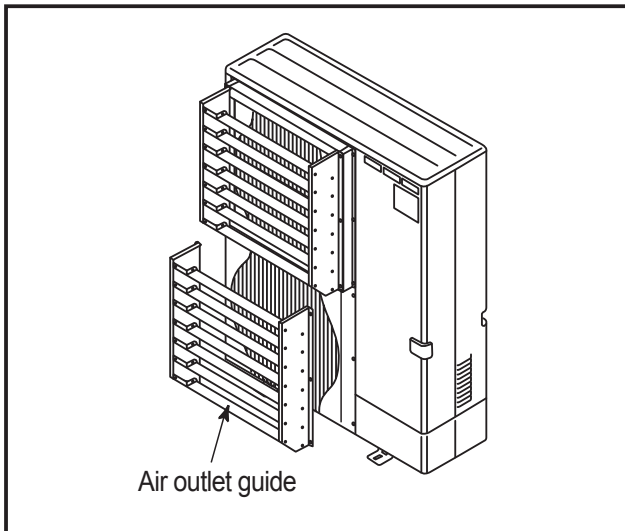

Figure



Descriptions

A part to change air direction from outdoor unit. Can also be used to prevent short cycles.

Applicable Models

- PUAZ-RP100~250KA
- 2 pieces required

Specifications

Exterior	Color (Munsell)	Ivory (3.0Y 7.8/1.1)
	Material	Air outlet grille: Alloy hot-dip zinc-coated carbon steel sheet
Weight		7kg
Air outlet direction		Changeable between up, down or sideways
Accessory name x Qty. <Material/Surface treatment>		Washer faced screw (M5x15) x 12 (Iron wire (SWCH18A)/Zinc nickel plated) Washer x 12, Spring washer x 12

Dimensions

Unit : mm

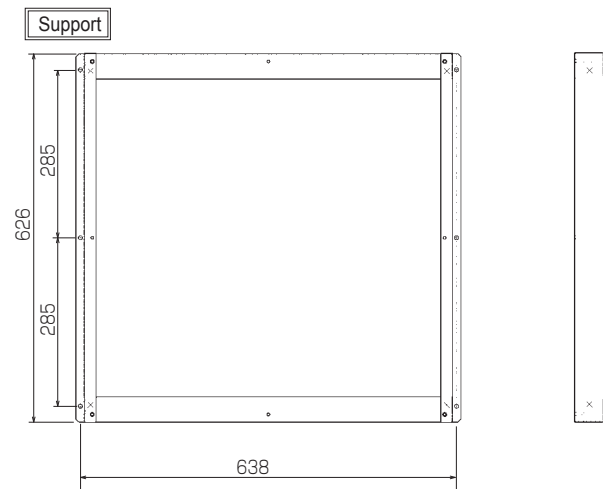
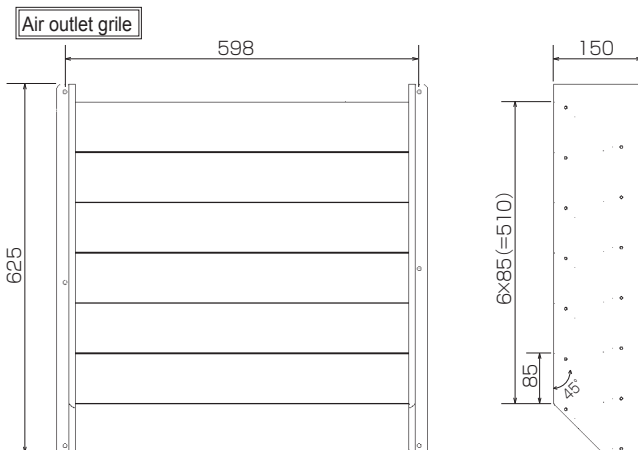

⚠ CAUTION

* Air Guide prevents reverse rotation of outdoor unit fan when it enters low speed rotation mode with fan controller being operated. It is also used for protection of fan when strong winds, such as a typhoon, wind blowing through tall buildings, etc., directly strike the air outlet. In addition, installation of this product is necessary when cooling operation is to be performed in outdoor temperature of -5°C or lower (down to -15°C).

Note the followings when installing this guide:

- 1) Be sure not to use "upward discharge" in a place where snowing is possible. Snow may accumulate in the guard, which could damage the fan, etc.
- 2) Attaching this unit will decrease the performance (by 2-3%) and increase noise from outdoor unit (by approx. 1-2 dB).
- 3) Do not use "upward discharge" when there are any obstacles at the back and on both sides of outdoor unit (air is taken in from top of unit): This could cause a short cycle.
- 4) To eliminate the influence of external wind, be sure to install the unit with its back facing to wall.
- 5) Do not install this unit in a place where wind directly blows to the back of the unit.





OPTIONAL PARTS

How to Use / How to Install

2-fan type outdoor unit

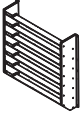
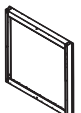
1 Checking provided parts

Make sure that this package has the following parts as well as the installation sheet:

① Air Discharge guide	1	② Support	1	③ Screw(5×15)	12	④ Washer	12	⑤ Spring washer	12
									

2 Checking Installation Space (Unit: mm)

● Secure the necessary surrounding space shown below and select a place with less obstacles, to prevent a short cycle.

1) Surrounding space needed when installing one unit

• Do not use "upward discharge" in cases of figures (3) and (5) below.

(1) Obstacle at front
(open at back, sides and top)

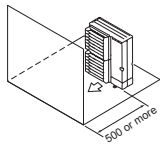

(2) Obstacles at back and front
(open at sides and top)

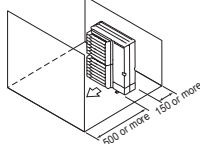

(3) Obstacles at back and top
(open at front and sides)

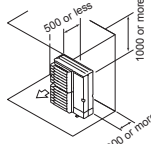

(4) Obstacles at back, and sides
(open at front and top)

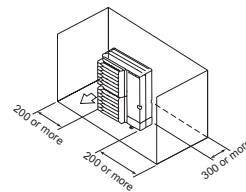

(5) Obstacles at back, sides and top
(open at front)

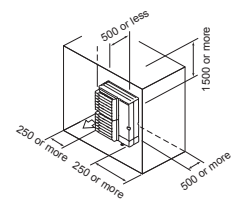

2) Surrounding space needed when installing multiple units

• When installing units horizontally in a series, leave at least 10 mm space between units.
• Do not use "upward discharge" in case of figure (3) below.

(1) Obstacle at front
(open at back, sides and top)

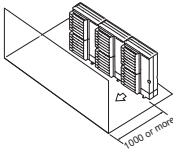

(2) Obstacles at back and front
(open at sides and top)

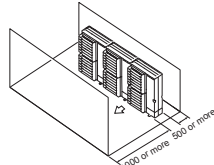

(3) Obstacles at back and top
(open at front and sides)

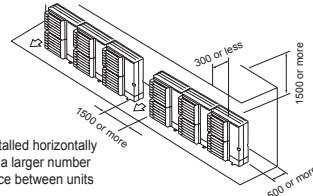

※Limit of 3 units can be installed horizontally in series. When installing a larger number of units, maintain the space between units shown above.

(1) Installing units, one in each row

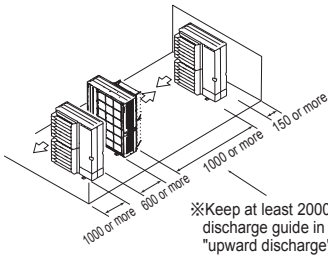

※Keep at least 2000 when using discharge guide in directions other than "upward discharge".

(2) Installing multiple units in multiple rows

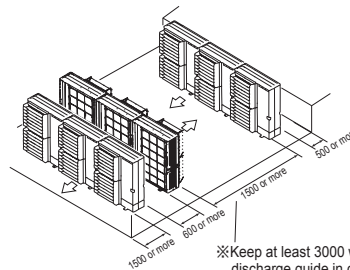

※Keep at least 3000 when using discharge guide in directions other than "upward discharge".

3 Installation Method

• 4 blowout directions can be selected: Check the orientation of blowout vane, and attach the blowout guide in the direction that matches the situation at local site.

(1) Attach the support ② to the outdoor unit using the washers ④, spring washers ⑤ and screws ③ (at the 6 points) on the existing fan guard

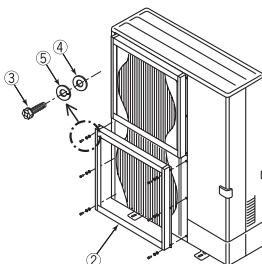

(2) Set the orientation of the blowout vane of the discharge guide ① to the desired direction and install the vane to the outdoor unit using the washers ④, spring washers ⑤ and screws ③ (at 6 points).

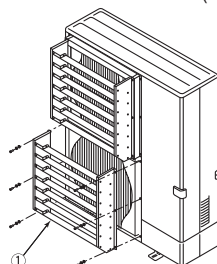

< Setting blow-off direction >

Upward	Downward	Sideways (to left or right)
