



Photo



Descriptions

Enables operation even when the outside temperature is low. Protect the unit from cold wind.

Applicable Models

- PUHZ-P100/125/140/200/250KA
- 2 pieces required

Specifications

Exterior	Color (Munsell)	Ivory (3.0Y 7.8/1.1)
	Surface treatment	Acrylic resin coating
	Material	Alloy hot-dip zinc-coated carbon steel sheet
Weight		3.5kg
Accessory name x Qty. <Material/Surface treatment>		Washer faced screw (M5x15) x 4 <Iron wire (SWCH18A)/Zinc nickel plated>

Dimensions

Unit : mm (inch)

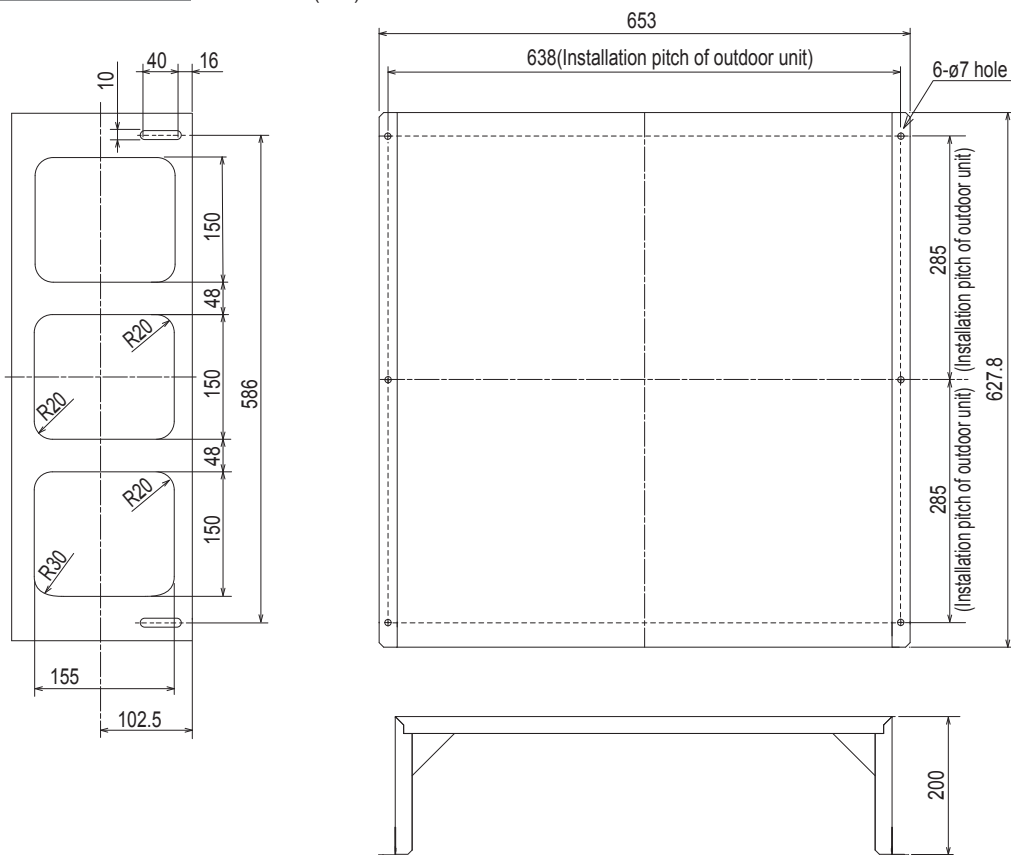

CAUTION

* Air Guide prevents reverse rotation of outdoor unit fan when it enters low speed rotation mode with fan controller being operated. It is also used for protection of fan when strong winds, such as a typhoon, wind blowing through tall buildings, etc., directly strike the air outlet. In addition, installation of this product is necessary when cooling operation is to be performed in outdoor temperature of -5°C or lower (down to -15°C).

Note the followings when installing this guide:

- 1) Be sure not to use "upward discharge" in a place where snowing is possible. Snow may accumulate in the guard, which could damage the fan, etc.
- 2) Attaching this unit will decrease the performance (by 2-3%) and increase noise from outdoor unit (by approx. 1-2 dB).
- 3) Do not use "upward discharge" when there are any obstacles at the back and on both sides of outdoor unit (air is taken in from top of unit): This could cause a short cycle.
- 4) To eliminate the influence of external wind, be sure to install the unit with its back facing to wall.
- 5) Do not install this unit in a place where wind directly blows to the back of the unit.

OPTIONAL PARTS

How to Use / How to Install

Always observe for safety

- Carefully read this section 「Always observe for safety」, and securely install the optional parts.
- Be sure to observe the cautions described here: They include critical contents for safety.
- The following indications show the classifications for danger, and possible consequences following incorrect handling.

⚠ WARNING Incorrect handling could lead to death or serious injury.

⚠ CAUTION Incorrect handling could lead to injury or damage to house and household articles.

- After installation, perform a test run and make sure that there is no abnormality, and ask your customer to keep this installation sheet with the instruction manual at all times. Also ask the customer to transfer these manuals to a new user if the user changes.

⚠ WARNING

Ask the dealer or specialist for installation.

Carefully install the panel according to this installation sheet.

- If installed incorrectly by user, water leak, electric shock, fire, etc. could result.

- Incorrect installation could cause water leak, electric shock, fire, etc.

Before performing installation (moving) and electrical work

⚠ CAUTION

Do not place polyethylene bags in reach of young children.

If electrical work is necessary, use only specified electric wires adapted with current capacity.

- Putting them over the head will block breathing passages, which could result in suffocation.

- Use of unsuitable wire could cause electric leak, overheating or fire.

Securely apply heat-insulation to refrigerant pipe so that no condensation occurs.

Securely perform drain piping work according to the installation manual so that no condensation occurs.

- If heat-insulation is inadequate, condensation could occur on the surface of pipes and dewdrops could accumulate on ceiling, floor or important goods.

- If piping work is incorrect, water leak may occur and ceiling, furniture, etc may get wet.

This Air Guide prevents reverse rotation of outdoor unit fan when it enters low speed rotation mode with fan controller being operated. It is also used for protection of fan when strong winds, such as in a typhoon, wind blowing through tall buildings, etc., directly strike the air outlet.

In addition, installation of this product is necessary when cooling operation is to be performed in outside-air temperature of -5°C or lower (down to -15°C).



Pay attention to the following points when installing this product:

- 1) To eliminate the effects of external wind, be sure to install this unit with back surface facing wall side.
- 2) Do not install this unit in orientation or site where wind directly blows at the back of the unit.
- 3) Installing of this product will reduce the capacity of the unit (approx. 2 or 3%) and increase the noise of outdoor unit (approx. 1 or 2dB).
- 4) Do not use this product where there is any obstacle at either side or above the outdoor unit (discharged air will be blocked). This may cause a short cycle.

When 2-fan type outdoor unit is used, note that two sets of this product will be necessary.

1 Checking parts

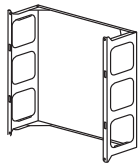
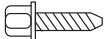
Make sure that all the following parts, in addition to this manual, are in this box:

① Air Guide	1	② Mounting screw (5×15)	6	③ Washer	6	④ Spring washer	6
							

OPTIONAL PARTS

2 Requirements of space for installation

(Unit : mm)

(1) One unit installation

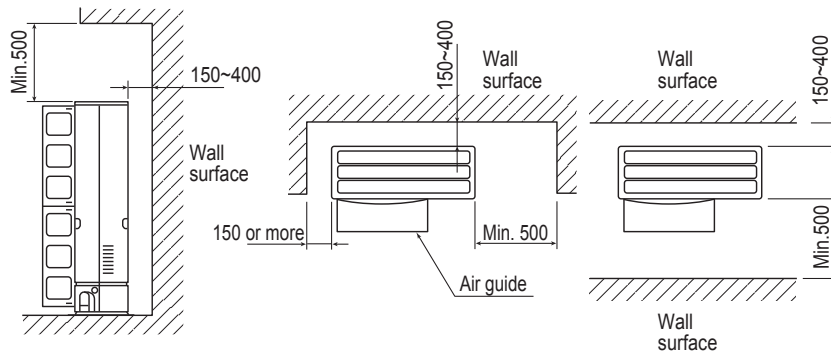

(2) Multiple unit installation : Installation of multiple units in series must be no more than 5 units.

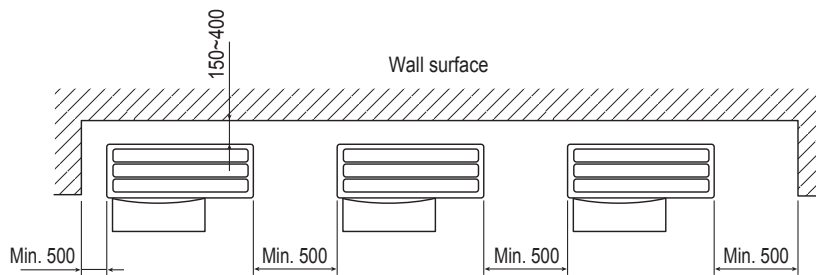
**3 Installation procedure**

(1) Install the air guide ① on the outdoor unit using washers ③, spring washers ④ and screws ②.

